

Camdollies®

For Tray and Sheet Pan Camcarrier®

With Handle

Models CD1826MTC (No photo shown),
CD1826MTCHB

Features & Benefits



- Make any job easier by smoothly transporting the Tray and Sheet Pan Camcarrier, Model 1826MTC, with this rugged and reliable Camdolly!
- Load capacity is 350 lbs. (159 Kg.).
- One-piece seamless, double-wall, high-density polyethylene construction is extremely durable. Won't dent, crack, rust, chip or break.
- Rounded corners protect walls, equipment, and furniture from damage.
- Foamed-in-place polyurethane insulation adds greater structural strength and reduces noise.
- Easy to clean - can be wiped down or steam cleaned.
- Molded-in handle is sturdy and provides controlled handling and maneuvering. Won't bend or break.
- Heavy-duty casters are bolted into molded-in steel plates. Provides quiet service and greater durability when fully loaded.
 - Model CD1826MTC - Four each 5" (12,7 cm) casters, 2 fixed, 2 swivel, 1 w/ brake
 - Model CD1826MTCHB - Two each rear 10" (25,4 cm) Easy Wheels and 2 each 5" (12,7 cm) swivel casters, 1 w/ brake
- No assembly required.
- Available in 5 colors.

Item No. _____

Specifier Identification No. _____

Model No. _____

Quantity _____



For Camcarrier 1826MTC
(Camcarrier for Trays &
Sheet Pans)



CD1826MTCHB

Approvals



Camdollies®

For Tray and Sheet Pan Camcarrier®

With Handle

Models CD1826MTC (No photo shown),
CD1826MTCHB

Item No. _____

Specifier Identification No. _____

Model No. _____

Quantity _____

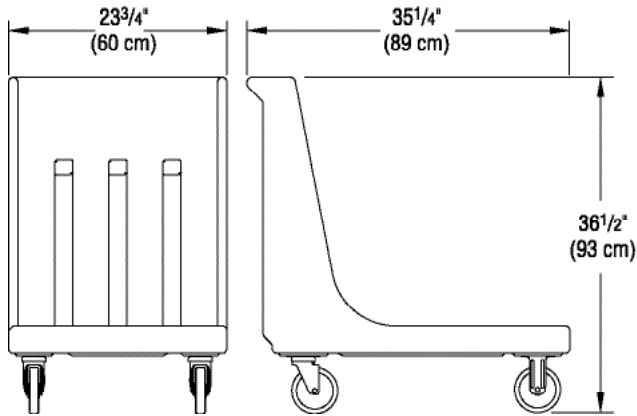

CD1826MTC

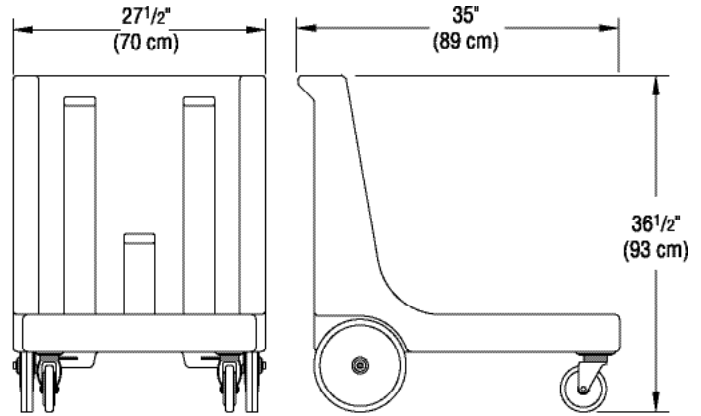

CD1826MTCHB (With Easy Wheels)

Specifications

Dimension Tolerance: +/- 1/4" (0,64 cm)

Code	Description	Load Capacity	Interior Dimensions W x L	Exterior Dimensions L x W x H	Case lbs./cube Kg/m ³
CD1826MTC	Camdolly	350 lbs. (159 Kg.)	22" x 28 1/2" (56 x 72 cm)	35 1/4" x 23 3/4" x 36 1/2" (89 x 60 x 93 cm)	35 (17,40) 16 (0,49)
CD1826MTCHB	Camdolly	350 lbs. (159 Kg.)	21 1/8" x 28 3/16" (56 x 73 cm)	35" x 27 1/2" x 36 1/2" (89 x 70 x 93 cm)	48 (20,98) 22 (0,59)

Architect Specs

The Camcarrier transport cart shall be a Camdolly, Cambro Model CD1826MTC or CD1826MTCHB manufactured by Cambro Mfg. Co., Huntington Beach, CA 92648 U.S.A. It shall be constructed of single-molded, seamless, double-wall, high-density polyethylene and thick foam injected polyurethane. It shall transport the Tray and Sheet Pan Camcarrier, Model 1826MTC. It shall be available with a load capacity up to 350 lbs. (159 Kg.). It shall have rounded corners. It shall have a molded-in handle. It shall be available with 4 each 5" (12,7 cm) swivel casters, no brake. Or it shall be available with 2 each 10" (25,4 cm) Easy Wheels and 2 each 5" (12,7 cm) swivel casters, 1 w/ brake. The casters shall be bolted into molded-in metal plates. It shall not require any assembly and shall be available in 5 colors.

Standard Colors

- Coffee Beige (157)
- Dark Brown (131)
- Black (110)
- Slate Blue (401)
- Gray (180)

Approvals

